

NOTES:

1. ALL DIMENSIONS ARE IN MILLIMETERS.
DIMENSIONS SHOWN ARE PROJECTED DISTANCES.
2. THE HEAT STRENGTHENED GLASS THICKNESS: 6 mm NOMINAL.
3. TRANSDUCERS ARE LOCATED AT THE POSITIONS SHOWN.
GLASS IS BEVELED UNDER TRANSDUCERS.
4. CABLES ARE ROUTED ALONG THE EDGE OF THE GLASS.
5. THE TOUCH ACTIVE AREA IS LESS THAN THE VIEWABLE AREA TO FACILITATE SEALING.
6. ARRAY PATTERNS ARE CENTERED ON GLASS WITH A TOLERANCE OF ± 1.3 mm.

CONNECTION CHART			
PIN	SIGNAL	INSULATION COLOR	JACKET COLOR
1	GROUND	OVERALL SHIELD	
2	KEY		
3	Y RECEIVE+	BLU	BLK
4	Y TRANSMIT+	BLU	GRY
5	Y RECEIVE-	BLK	BLK
6	Y TRANSMIT-	YEL	GRY
7	GROUND	INNER SHIELD	
8	X TRANSMIT-	RED	RED
9	X RECEIVE-	RED	BLK
10	X TRANSMIT+	GRN	RED
11	X RECEIVE+	WHT	BLK
12	KEY		

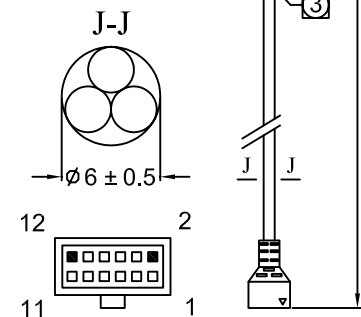

宇鴻光電股份有限公司 ATouch Technologies Co., Ltd.		
P/N:		SAW121T2G1
DRAWN BY	DIMENSION UNIT	ISSUE DATE
KEN	mm	05 / 21 / 07
CHECKED BY	SCALE	REV
MELISSA	NOT TO SCALE	E